

Designer Marie Burgos has expanded on the design concept for her acclaimed Milo lounge chair and created the newly introduced Milo sofa. She uses a molded wooden frame to support the luxuriously comfortable seating that is covered in any of a wide selection of fabrics, including the red velvet shown here. The tailored contemporary style is designed to compliment room settings in virtually any style from traditional to minimalist modern.

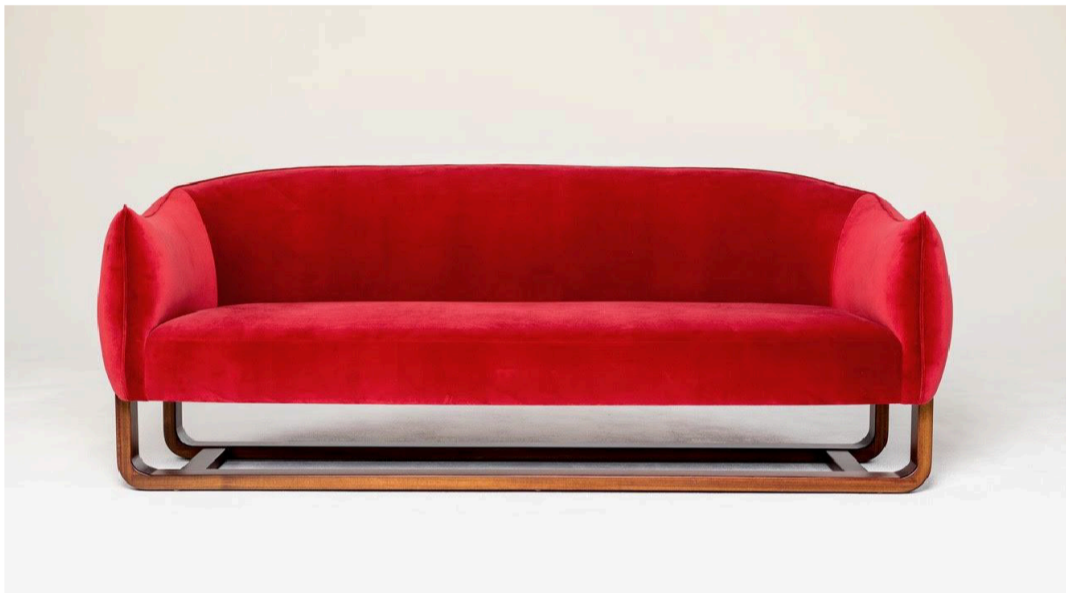

## MILO SOFA

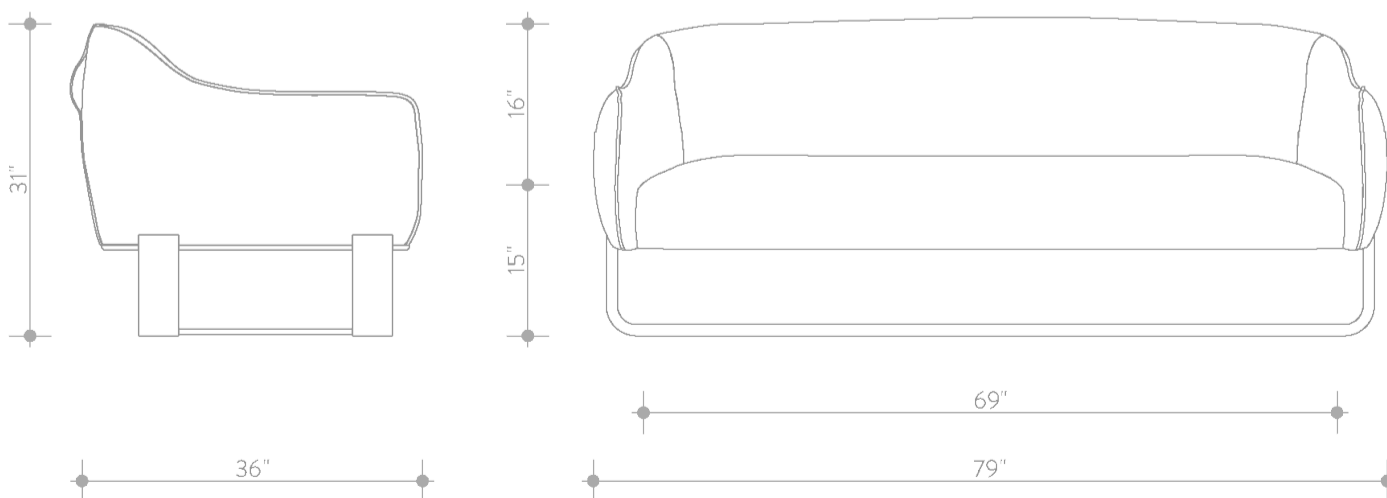

### MATERIALS

Solid oak foot

### STRUCTURE

Handcrafted wooden frame

### FINISH

Variety of fabrics with leather handle. COM available

### DIMENSIONS

Width: 79"  
Depth: 36"  
Height: 31"

# MB

COLLECTION

MARIE BURGOS COLLECTION

## PERFORMANCE VELVET



Fine - Nuage



Fine - Dune



Fine - Wood



Fine - Safran



Fine - Dijon

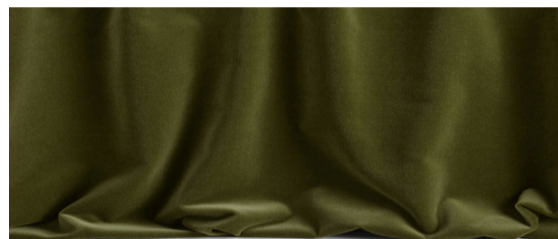

Fine - Kiwi

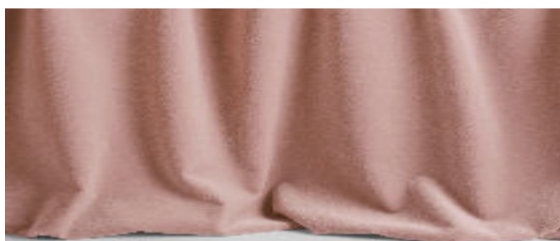

Fine - Powder



Fine - Wine



Fine - God Save The Queen



Fine - Duck

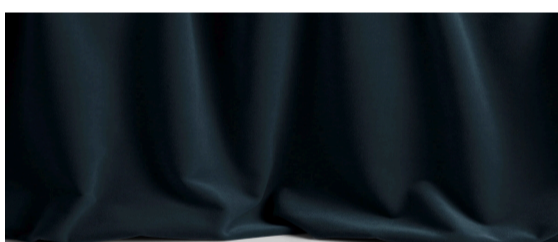

Fine - Méditerranée



Fine - Simple Black

## PERFORMANCE CHENILLE VELVET



Freddo - Pearla



Freddo - Orzo



Freddo - Duna



Freddo - Ambra



Freddo - Pesca

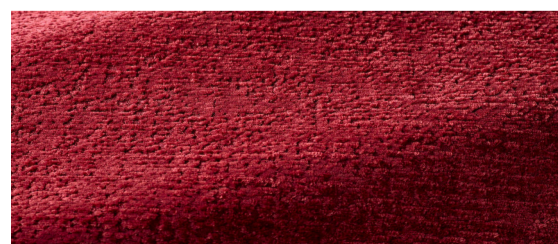

Freddo - Mirtillo

# MB

COLLECTION

MARIE BURGOS COLLECTION

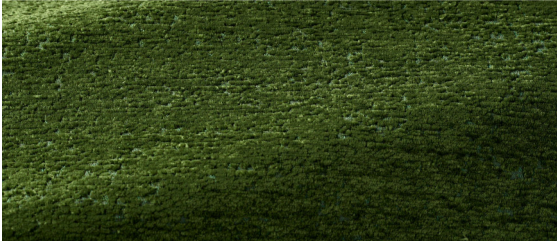

Freddo - Antica

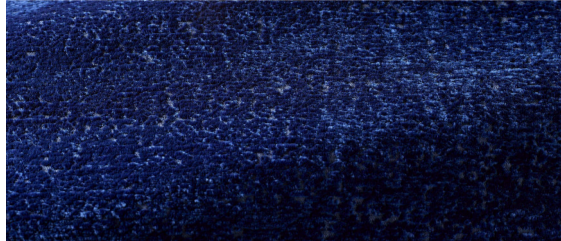

Freddo - Marina



Freddo - Corteccia

## PREMIUM BOUCLE WOOL



Opio - Naturel



Opio-Orzo



Opio- Ciottolo



Opio- Ambra



Opio- Kiwi



Opio- Eucalipto



Opio- Azalea

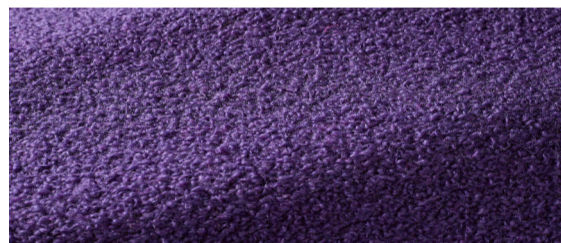

Opio- Porpora



Opio- Indaco

## HANDLES LEATHERS

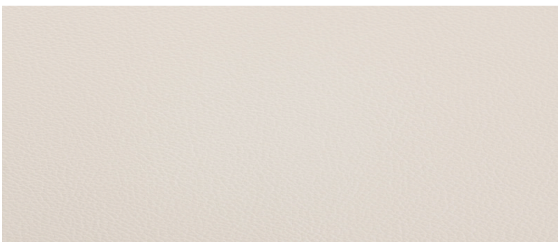

Shelly - White



Old English - Saddle

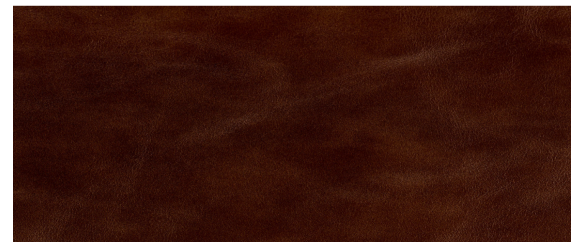

Belmont - Tobacco